

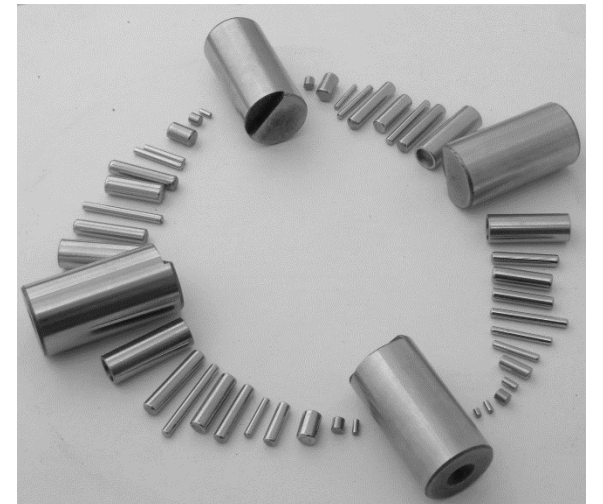

SKP Bearing Industries Limited

A very warm welcome to all....





DISCLAIMER

This Investor Presentation has been prepared by SKP Bearing Industries Limited (SKPBIL) and does not constitute a prospectus or placement memorandum or an offer to acquire any securities. This presentation or any other documentation or information (or any part thereof) delivered or supplied should not be deemed to constitute an offer. No representation or warranty, express or implied is made as to, and no reliance should be placed on, the fairness, accuracy, completeness or correctness of such information or opinions contained herein. The information contained in this presentation is only current as of its date. Certain statements made in this presentation may not be based on historical information or facts and may be “forward looking statements”, including those relating to the general business plans and strategy of SKPBIL its future financial condition and growth prospects, future developments in its industry and its competitive and regulatory environment, and statements which contain words or phrases such as ‘will’, ‘expected to’, ‘horizons of growth’, ‘strong growth prospects’, etc., or similar expressions or variations of such expressions. These forward-looking statements involve a number of risks, uncertainties and other factors that could cause actual results, opportunities and growth potential to differ materially from those suggested by the forward-looking statements. Further, no representation or warranty expressed or implied is made nor is any responsibility of any kind accepted with respect to the completeness or accuracy of any information. Also, no representation or warranty, express or implied, is made that such information remains unchanged in any respect as of any date or dates after those stated herein with respect to matters concerning any statement made in this Investor Presentation. SKPBIL may alter, modify or otherwise change in any manner the content of this presentation, without obligation to notify any person of such revision or changes. This presentation cannot be copied and disseminated in any manner. No person is authorized to give any information or to make any representation not contained in and not consistent with this presentation and, if given or made, such information or representation must not be relied upon as having been authorized by or on behalf of SKPBIL. This presentation is strictly confidential. The earlier versions of this presentation, were in draft form, and should not be circulated or referred to by any person.

 **Beginning 1991**, Formed as a Partnership Firm in the name and style of “S K P Bearing Industries”



Product Range.

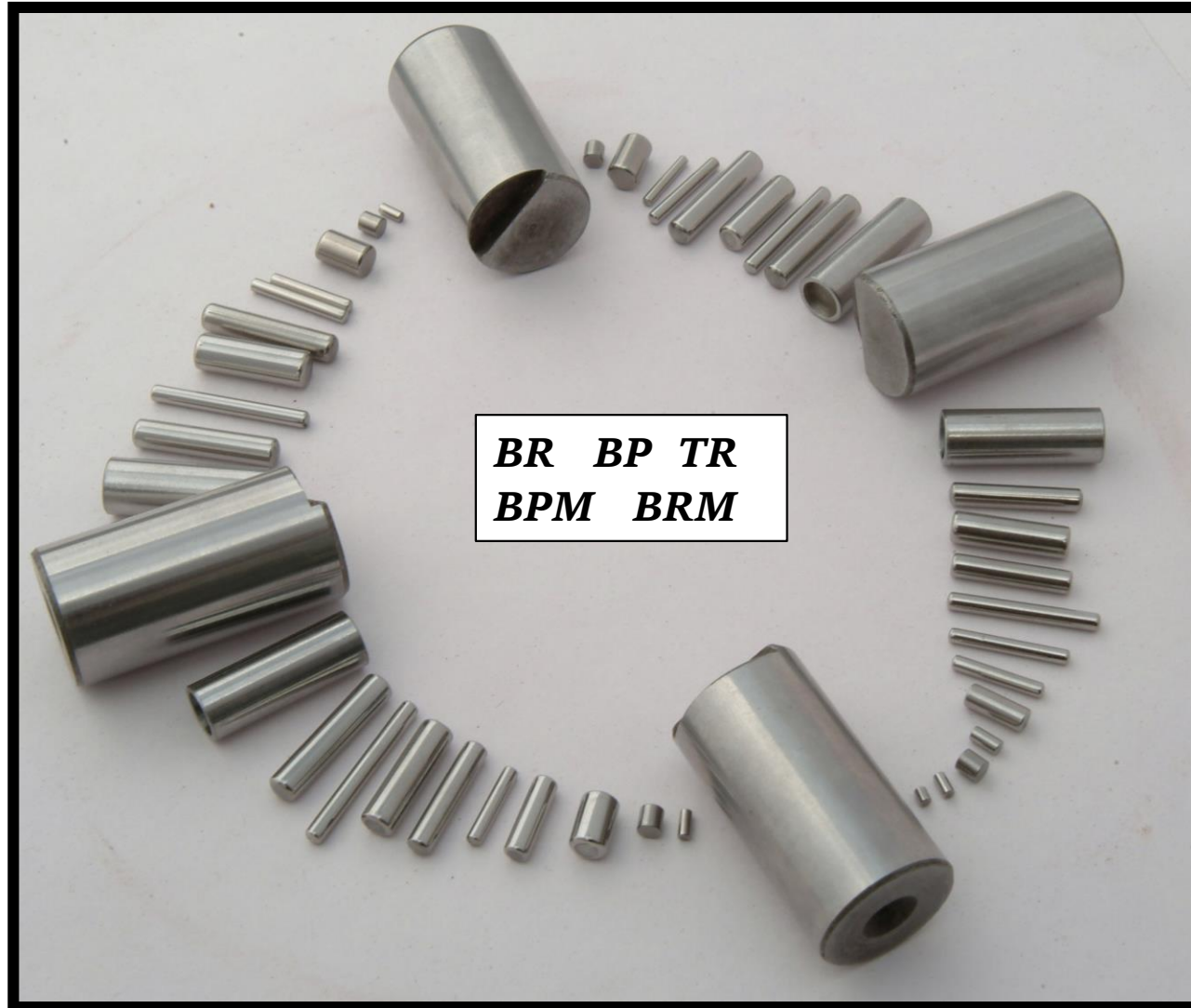

Range of production :

- *Diameter: 1.25mm to 30.00mm*
- *Length: 3.00mm to 100mm*

SKP PRODUCTS APPLICATIONS

BEARINGS



FOR VARIOUS APPLICATIONS.

Accelerators

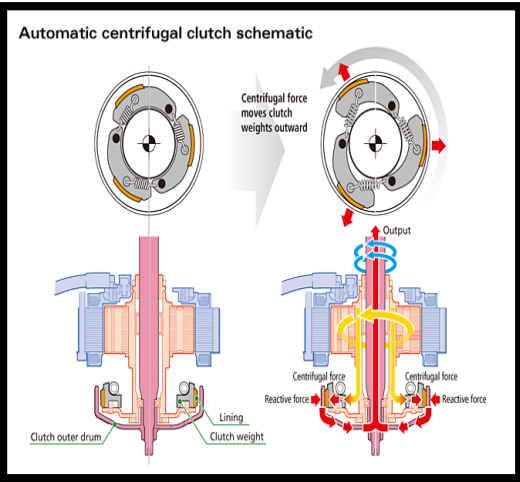

Transmission / Starters

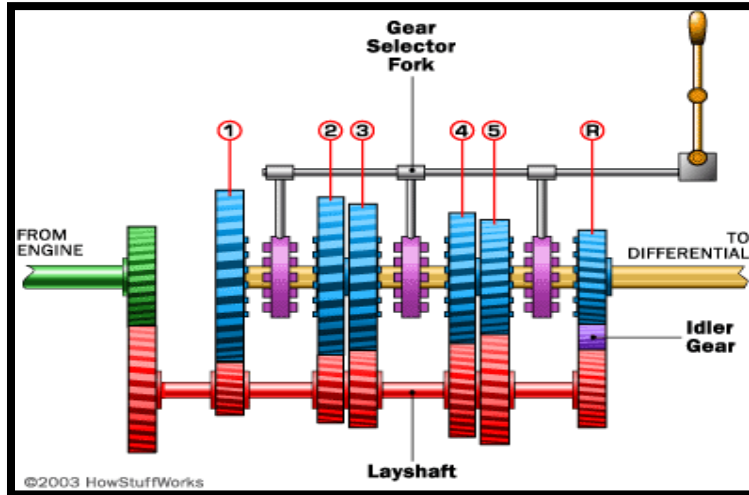

CAM FOLLOWERS



Car Gears

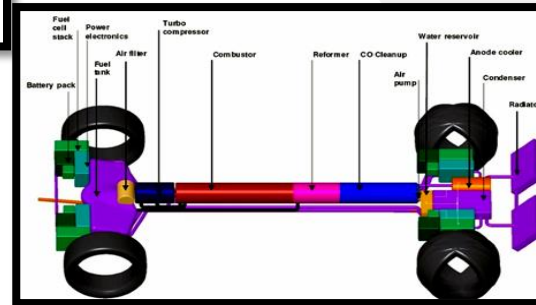

ROCKER ARMS

UNIVERSAL JOINTS,

Motorcycle gears

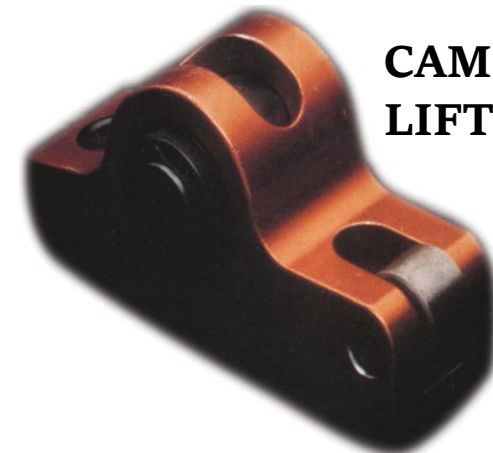
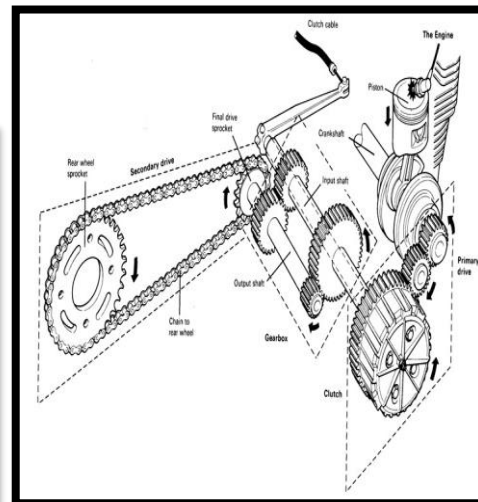

CAM LIFTERS

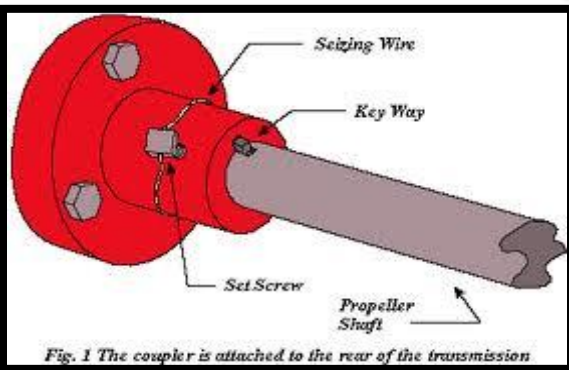

Propeller Shaft

Steering

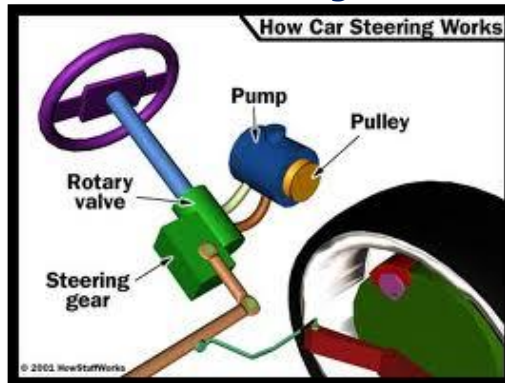

WATER PUMPS,



Factory Outlook -Unit I





2004 & 2008 Third phase expansion, setting up of Manufacturing Unit at Survey No. 2127, Mulchand Road



 **2010, Windmill**



 **2014, Solar plant at Various location**





📍 2018, Ball Plant

- In February 2018, SKP took over an already existing ball manufacturing plant in Jaipur.
- The plant was run in the same location for 2 years. Later in 2020 the plant was shifted and consolidated with the Surendranagar plant.



Product Range.



*Balls of G5 grade from
3.968 mm to 22.225 mm*

SKP PRODUCTS APPLICATIONS

Seats



Bearings



Steering

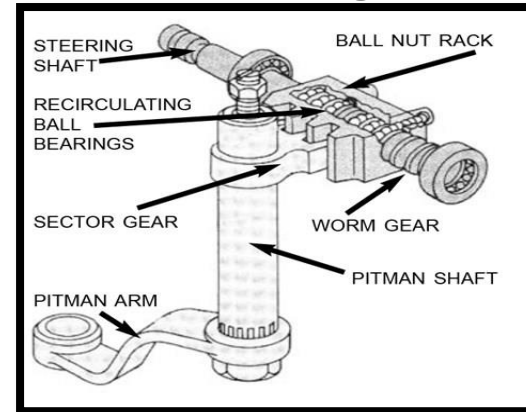

WATER PUMPS

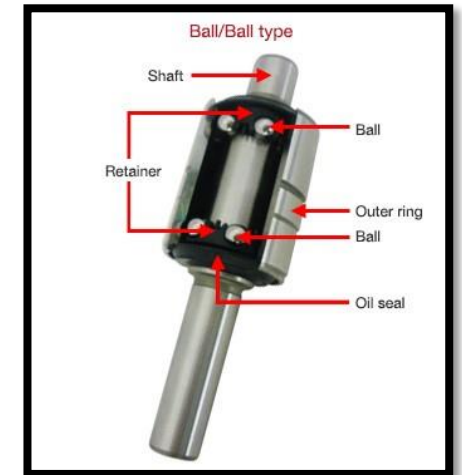

Cycles



Brakes

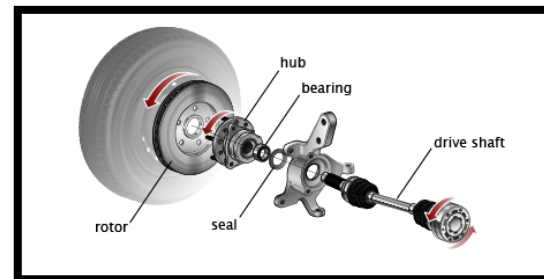

Accelerators

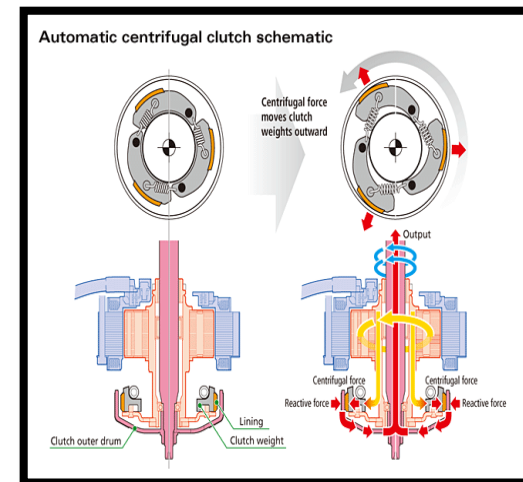

FOR VARIOUS APPLICATIONS

 2020, Fourth Expansion



SKP factory is spread over an area of 54000 Sq. Ft.



Address:
Survey No. 2127,
Mulchand Road,
Wadhwan,
Surendranagar,
Gujarat

Total Facility



INSTALLED CAPACITY

Rollers: 600 MILLION PCS / ANNUM

Balls: 360 MILLION PCS / ANNUM

Rollers: 1320 TONES / ANNUM

Balls: 960 TONES / ANNUM

UTILISED CAPACITY

Rollers: 480 MILLION PCS / ANNUM

Balls: 54 MILLION PCS / ANNUM

Rollers: 1200 TONES / ANNUM

Balls: 540 TONES / ANNUM



Quality Standards :

IATF 16949
Certified By TUV Seudland
Date Of Issue : 3.12.20
Valid Till : 2.12.23



 2022, Converted to Public Limited.



On January 07, 2022 Company had been converted into a public limited company and the name of our Company changed to

“SKP Bearing Industries Limited”



Mr. S. K. Palshikar

Promoter, Chairman & Managing Director

He specialized in Production Engineering with Masters from IIT Bombay. He has knowledge and experience of more than 30 years in the field.



Mrs. S. S. Palshikar

Non-Executive Director

She is experienced in Finance and administration. She is a Presidential award winner for “Outstanding women Entrepreneur”.



Mr. Kishor Parikh

Non-Executive Director

He is a Practicing Chartered Accountant under his firm name M/s K.C. Parikh & Associates. He has around 35 years of experience in the field of audit, taxation, accounts and finance.



Mr. Rajeev Lokare

Non-Executive Independent Director

He is Mechanical Engineer and has experience of around 40 years in operational excellence with the entire career focus on systems implementation and diversification for business development through expanding existing product, new product development and Joint Ventures. He has worked with various companies like Tata Motors Limited, TVS Motor Company Limited, Apollo Tyres Limited and many more.



➤ Financial Highlights

Financials Highlights :

Total Revenue (in Cr.)

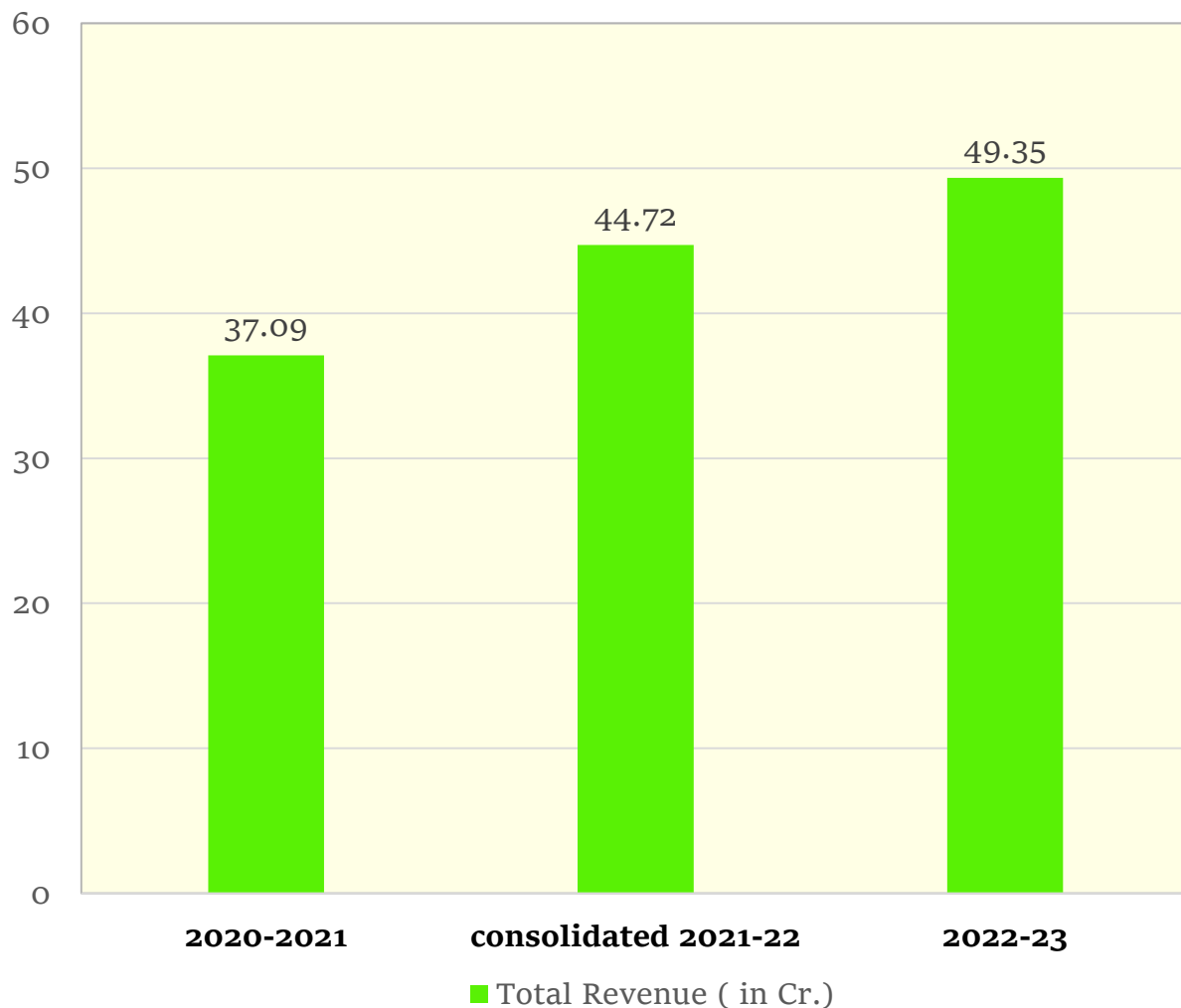

EBITDA (in lakhs)

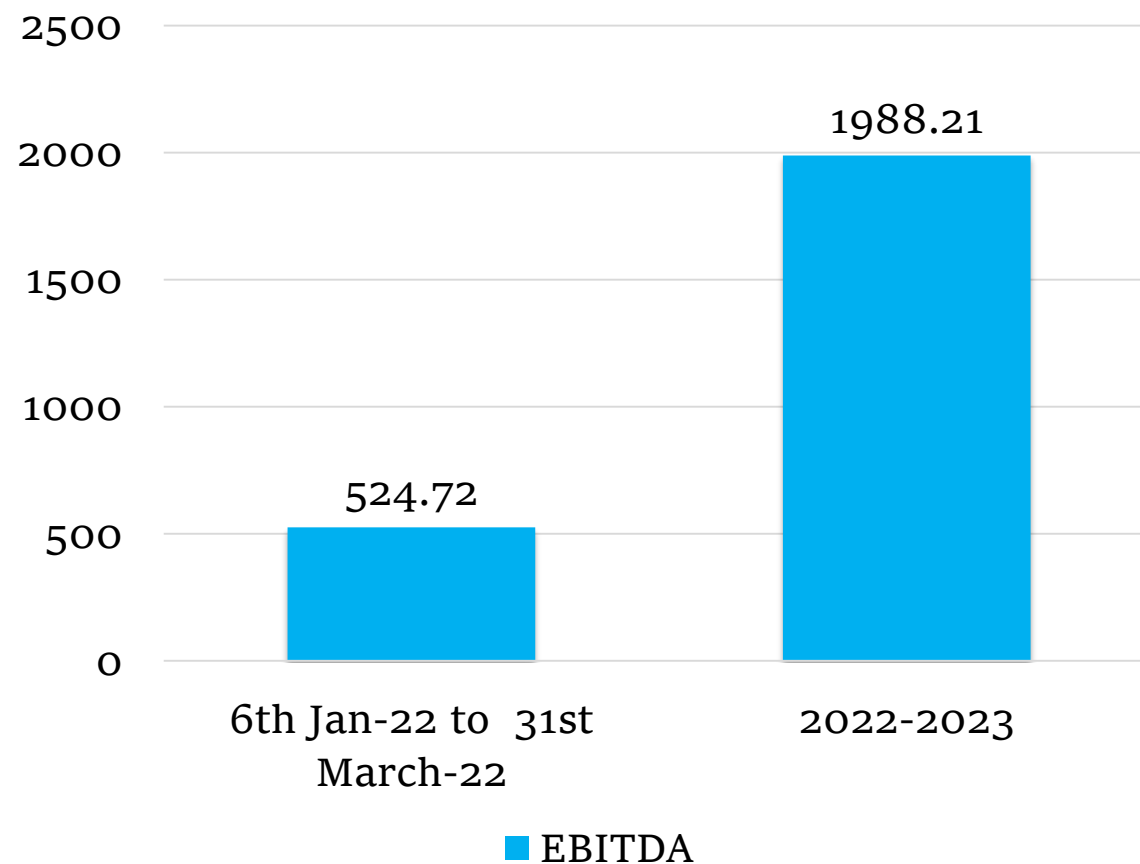

Financials Highlights :

Profit comparison

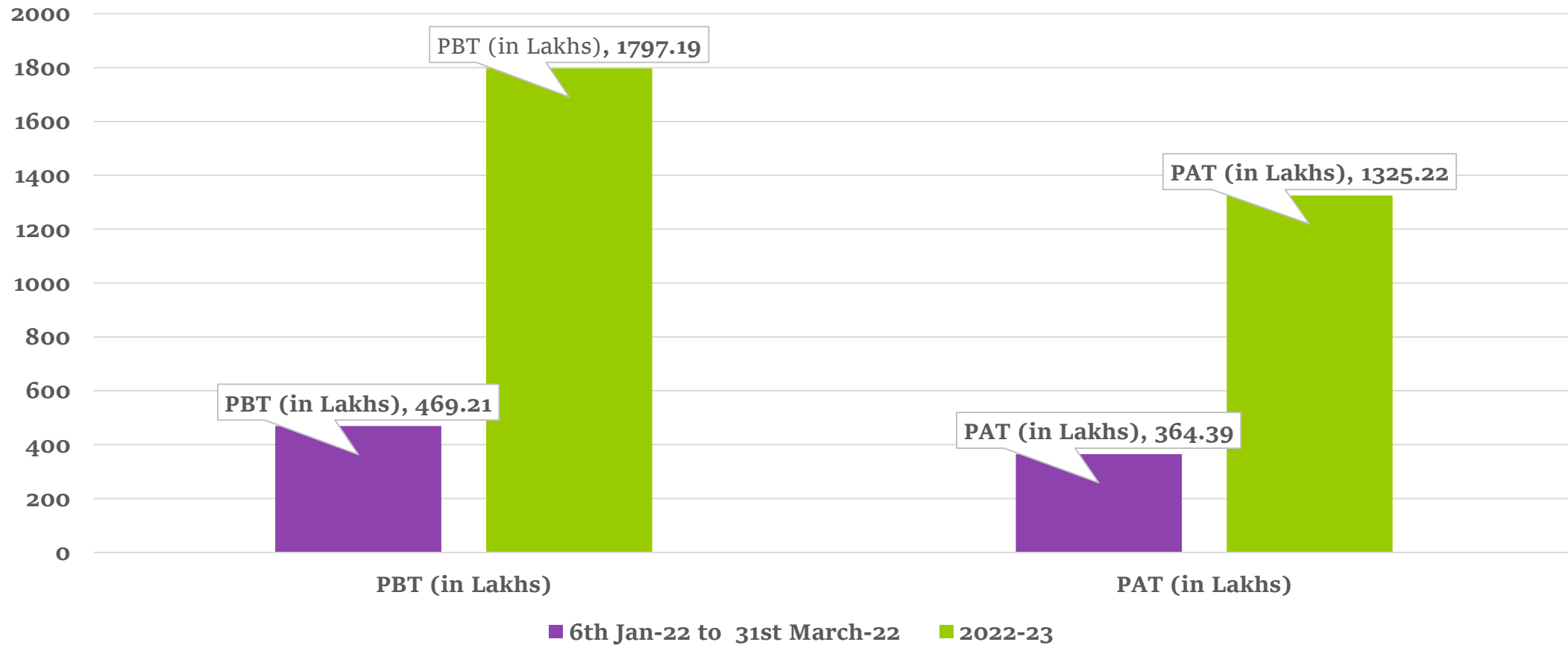

Balance Sheet:

SKP BEARING INDUSTRIES LIMITED
CIN : L29305GJ2022PLC128492
BALANCE SHEET AS AT 31/03/2023

In ₹

Particulars	Note No.	as at 31/03/2023	as at 31/03/2022
EQUITY AND LIABILITIES			
Shareholders' funds			
Share capital	2.1	166000000	150000000
Reserves and surplus	2.2	245892133	36439441
Money received against share warrants		-	-
		411892133	186439441
Share application money pending allotment		-	-
Non-current liabilities			
Long-term borrowings	2.3	39912942	184080959
Deferred tax liabilities (Net)	2.4	4090992	916176
Other Long term liabilities		-	-
Long-term provisions		-	-
		44003934	184997135
Current liabilities			
Short-term borrowings	2.5	142492	9390625
Trade payables	2.6		
Total outstanding dues of micro enterprises and small enterprises		1323810	1385941
Total outstanding dues of creditors other than micro enterprises and small enterprises		17178326	7584543
Other current liabilities	2.7	7299111	7953258
Short-term provisions	2.8	44231175	9565000
		70174914	35879367
TOTAL		526070981	407315943

BALANCE SHEET AS AT 31/03/2023

In ₹

Particulars	Note No.	as at 31/03/2023	as at 31/03/2022
ASSETS			
Non-current assets			
Property, Plant and Equipment and Intangible Assets			
Property, Plant and Equipment	2.9	216805545	188613079
Intangible assets		-	-
Capital work-in-progress	3.0	75228638	16790490
Intangible assets under development		-	-
		292034183	205403569
Non-current investments	3.1	3500500	16268629
Deferred tax assets (net)		-	-
Long-term loans and advances	3.2	7440579	2490556
Other non-current assets	3.3	28216	3357801
		303003478	227520555
Current assets			
Current investments		-	-
Inventories	3.4	52728785	44267501
Trade receivables	3.5	109762079	108805018
Cash and cash equivalents	3.6	303894	2806442
Short-term loans and advances	3.7	11896568	19779089
Other current assets	3.8	48376177	4137338
		223067503	179795388
Accounting Policies and Notes on Accounts	1.0		
TOTAL		526070981	407315943

STATEMENT OF PROFIT AND LOSS FOR THE YEAR ENDED 31/03/2023

In ₹

Profit and loss:

Particulars	Note No.	For the Year Ended 31/03/2023	For the Year Ended 31/03/2022
Revenue from operations	3.9	487630270	96771760
Other income	4.0	5884861	5964942
Total Income		493515131	102736702
Expenses			
Cost of materials consumed	4.1	137907435	19059153
Purchases of Stock-in-Trade	4.2	1133059	-
Changes in inventories of finished goods work-in-progress and Stock-in-Trade	4.3	(1851171)	(2537807)
Employee benefits expense	4.4	36671497	7448835
Finance costs	4.5	9077821	3386384
Depreciation and amortization expense	4.6	10378378	2164748
Other expenses	4.7	120479054	26294772
Total expenses		313796073	55816085
Profit before exceptional, extraordinary and prior period items and tax		179719058	46920617
Exceptional items	4.8	-	-
Profit before extraordinary and prior period items and tax		179719058	46920617
Extraordinary Items	4.9	-	-
Profit before prior period items and tax		179719058	46920617
Prior Period Items	5.0	-	-
Profit before tax		179719058	46920617
Tax expense:	5.1		
Current tax		44021552	9565000
Deferred tax		3174816	916176
Profit/(loss) for the period from continuing operations		132522690	36439441
Profit/(loss) from discontinuing operations	5.2	-	-
Tax expense of discontinuing operations		-	-
Profit/(loss) from Discontinuing operations (after tax)		-	-
Profit/(loss) for the period		132522690	36439441
Earnings per equity share:	5.4		
Basic		8	2
Diluted		-	-

Accounting Ratios:

Ratios	6th Jan-22 to 31st March-22	2022-2023
Gross Profit margin/ PBT%	46%	36%
Net Profit margin/ PAT%	35%	27%
EBITDA %	51%	40%
EBIT %	49%	38%
Employee Costs %	7.25%	7.43%
Depreciation %	2.11%	2.10%
cash conversion cycle in days	247	172
current ratio	5.01	3.18
quick ratio	3.78	2.43

Key Strengths:



1.

Our products are manufactured with advanced technology. Many of these technologies are **developed in-house**.

2

Global presence with a wide customer base across various industries. **No dependency on any one cluster of industries only.**
Presence in auto, textile, engineering, etc sectors

3.

Well oiled team with **over 30 years of experience**. Supplying custom make products as per customer requirements

4.

Impact of electricity is reduced by **self generation of electricity** by roof top solar and wind.

5.

One of the players in **manufacturing** of multiple rolling elements in India **under single roof**. With flexible chain the develop new products.

6.

Almost **Debt free** company



➤ Road Map for the nearest
future

3rd Unit where Ball will be a separate vertical.



Expansion of infrastructure facility to increase ball manufacturing capacity by 2.5 times.





To install continuous furnaces.

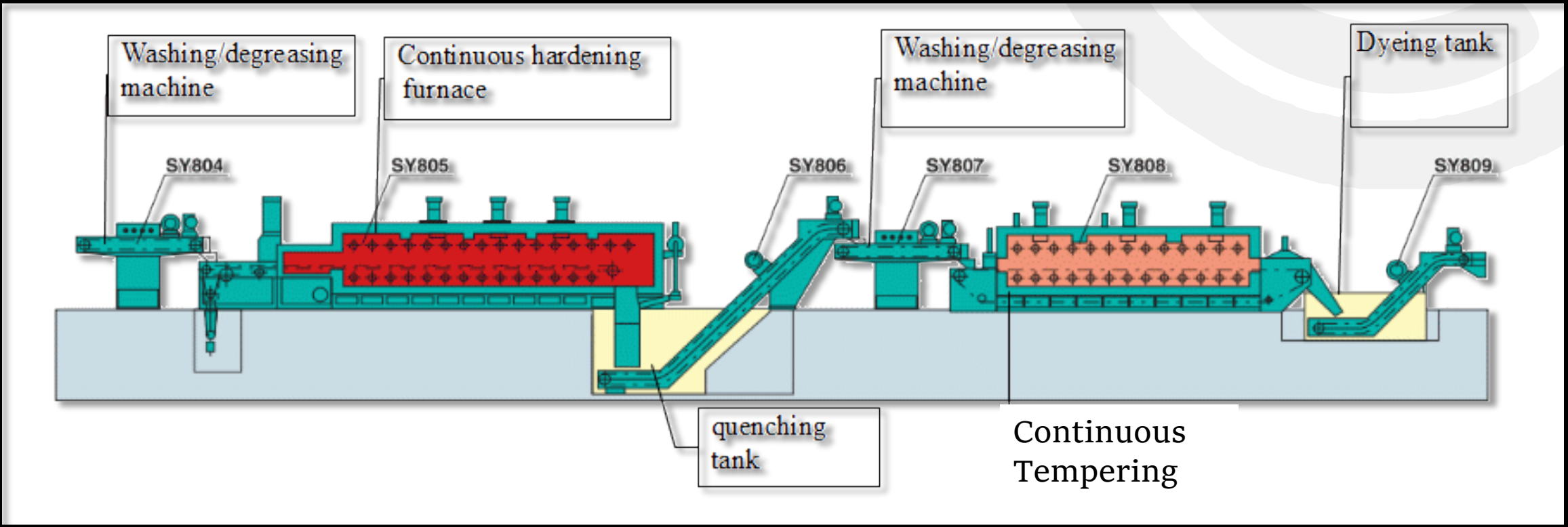



To implement Filtration plants.

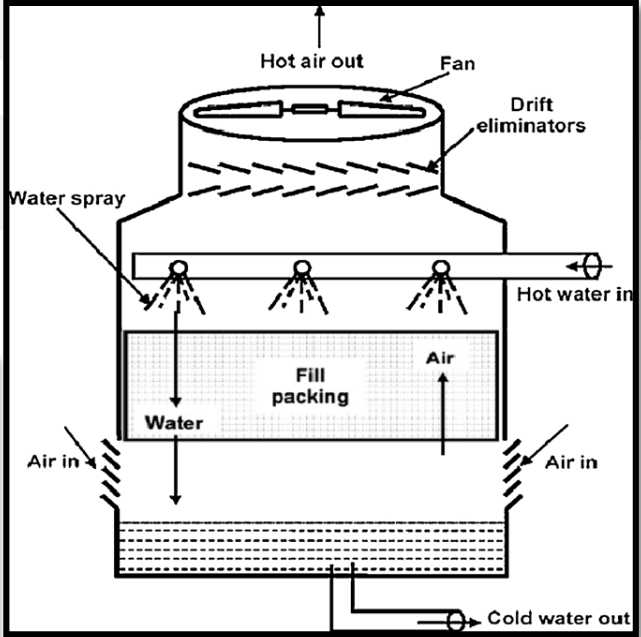
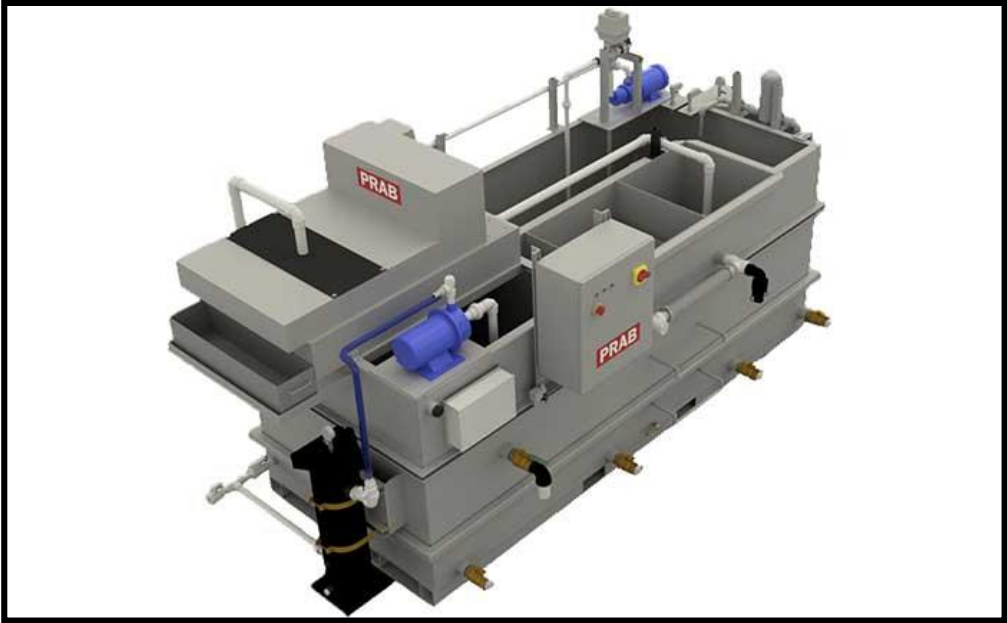

Artificial intelligence based systems.

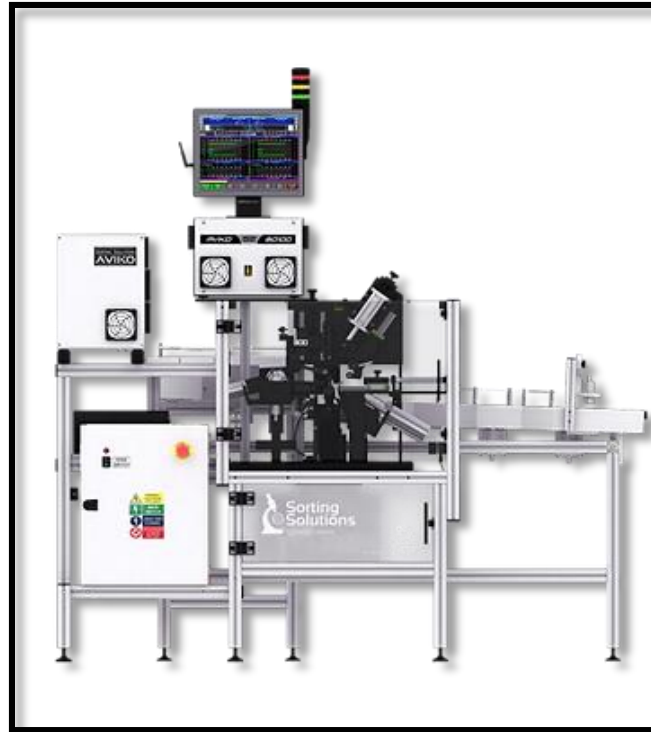

Up gradation of ERP System



The ongoing project of ERP up gradation will enhance SKP Bearing Industries Limited operational efficiency and streamlining internal processes by up this gradation.

Solar Energy in PM Kusum Yojna.

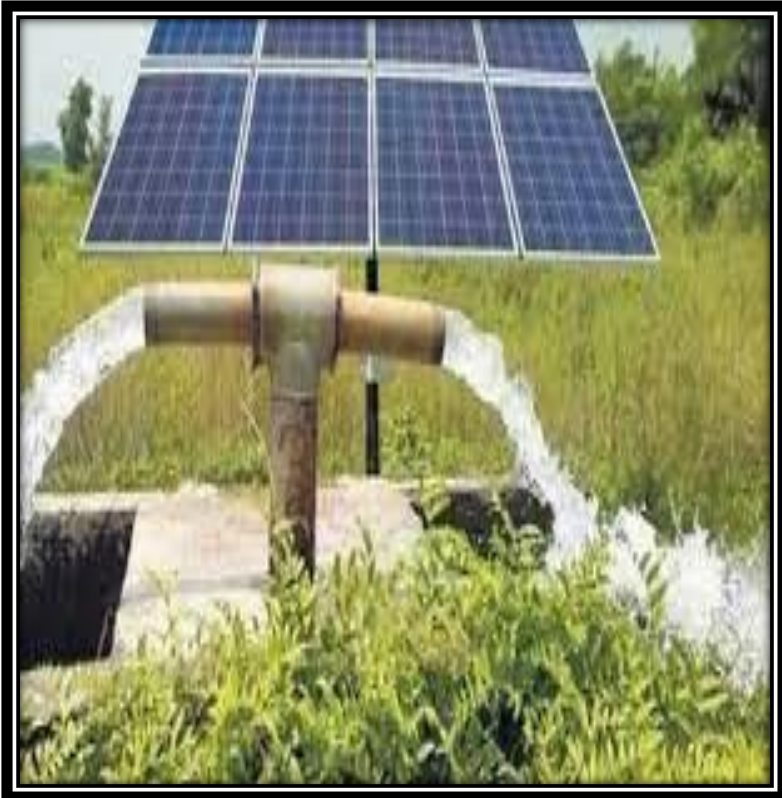

SKP Bearing Industries Limited has obtained approval for PM Kusum Yojna to generate solar energy. This gives us an opportunity to diversify revenue streams and Contribute to environmental conservation.

Completion of Registered office building



Completion of Registered office building



SKP Bearing Industries Limited ongoing project of expansion activity for final process area has been done and put to use in this year.

➤ Welfare Activities





Employee welfare



Appreciation

SKP Quarters



SKP Colony



Ganesh Yag (Family Get-together)



Trainings



Women's Day Celebration



Environment welfare



Tree Plantation

Rain Water Harvesting



Awarded with Special National Award as “Outstanding Entrepreneurship” in Women General category. And subsequent special awards.





Shri
Foundation

The main logo consists of a stylized 'S' shape. The left vertical stroke is black and curves at the bottom. The right vertical stroke is red and features a flame-like or flame-like shape at its top. The central part of the 'S' is filled with a red color and contains several white circular dots. To the right of this logo, the words 'Shri' and 'Foundation' are stacked vertically in a bold, red, sans-serif font.

Sweet Distribution



Sweater Distribution

Women Empowerment



Cultural Behavior

Uniform Distribution



SSC Board Exam Mock Test



Science & Computer Lab

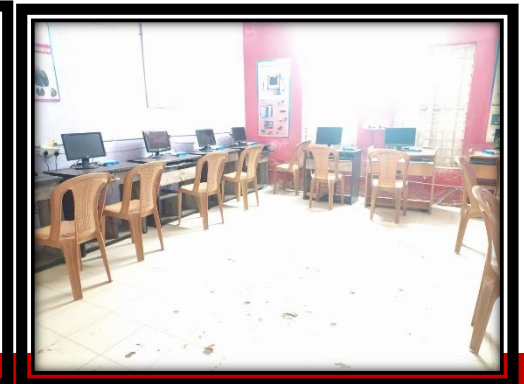

Restoration of Historical monument

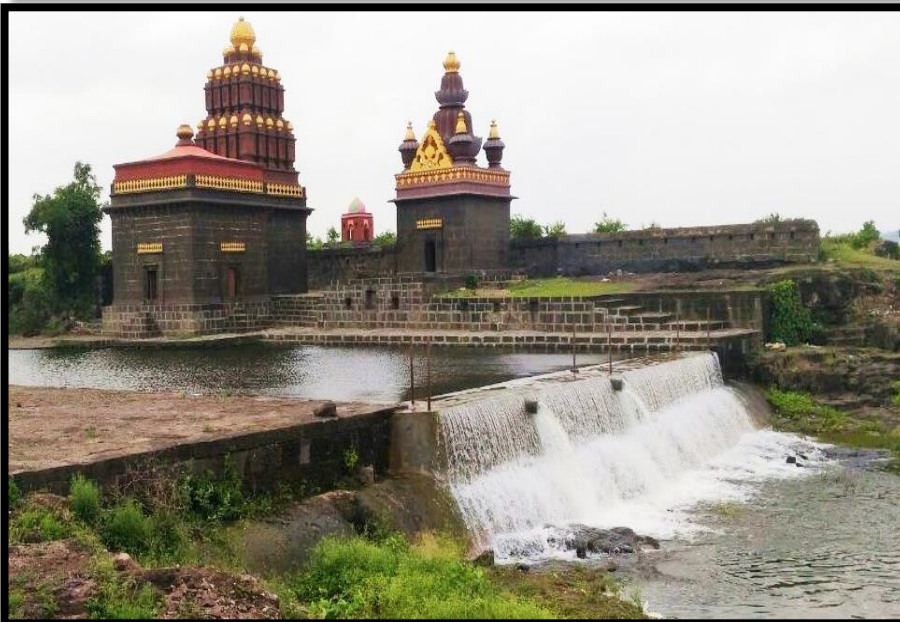

Looking forward to your Association



**SKP Bearing Industries
Limited**

Thank you