



## SKP Bearing Industries Limited

Previously known as : SKP Bearing Industries Pvt. Ltd. and also as SKP Bearing Industries  
Regd. Office/Works : Survey No.2127, Mulchand Road, Wadhwan City.

District : Surendranagar, Gujarat. Pin : 363030.

Email : [skpbearings@gmail.com](mailto:skpbearings@gmail.com), [sales@skpbearings.com](mailto:sales@skpbearings.com), [info@skpbearings.com](mailto:info@skpbearings.com)

Contact Info. : 9374326394 , 9374426396

Website : [www.skpbearings.com](http://www.skpbearings.com) | CIN No. : L29305GJ2022PLC128492 | IATF - 16949

National Stock Exchange of India Limited  
Exchange Plaza,  
Bandra Kurla Complex  
Bandra (E), Mumbai – 400051  
Symbol – INEOKZA01016

27/11/2023

Dear Sir / Madam

Sub: - Intimation of Institutional investor/ analyst meeting under SEBI (Listing Obligations and Disclosure Requirements) Regulations, 2015.

Pursuant to Regulation 30 of the Securities and Exchange Board of India (Listing Obligations and Disclosure Requirements) Regulations, 2015 ("SEBI LODR Regulations"), the senior management of the company will be interacting with a few institutional investors and analysts through Video Conferencing ("VC") on 28<sup>th</sup> November 2023.

The details of the interactions are provided below

Date and time	Particular	Type of meeting	Mode
November 28 <sup>th</sup> 2023 11:00 AM	Meeting between senior management of the company and institutional investors/analysts	One- to- One /Group	Video Conferencing

The meeting schedule is subject to last-minute changes, due to exigencies on the part of Analyst/ Institutional investors or the company.

The discussion will be under the purview of investor presentation enclosed herewith, which is also available on company's website <https://www.skpbearings.com/>

This is for your information and records.

Thanking you

Yours faithfully,

For SKP Bearing Industries Limited

  
Shrinand Palshikar  
Managing Director  
DIN -08992832

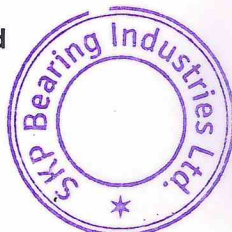



# SKP Bearing Industries Limited



A very warm welcome to all....

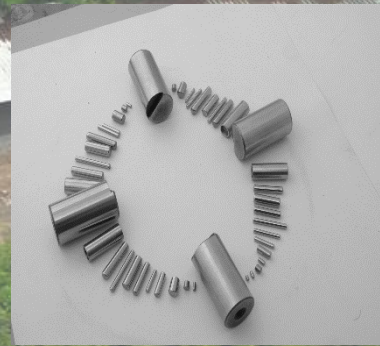



# Table of Contents:



*Introduction of  
SKPBIL*

*03*

*Other  
Plants*

*19*

*Roadmap for  
nearest future*

*24*

*Welfare  
Activities*

*33*

*Financial  
Highlights*

*42*

# About the company



SKP Bearing Industries was established in the year 1992.

We cater to the demands of the automotive, textile, bearing and other industrial sectors for the supply of

**“ Precision needle rollers, cylindrical rollers, pins and balls.”**



# SKP BIL Journey

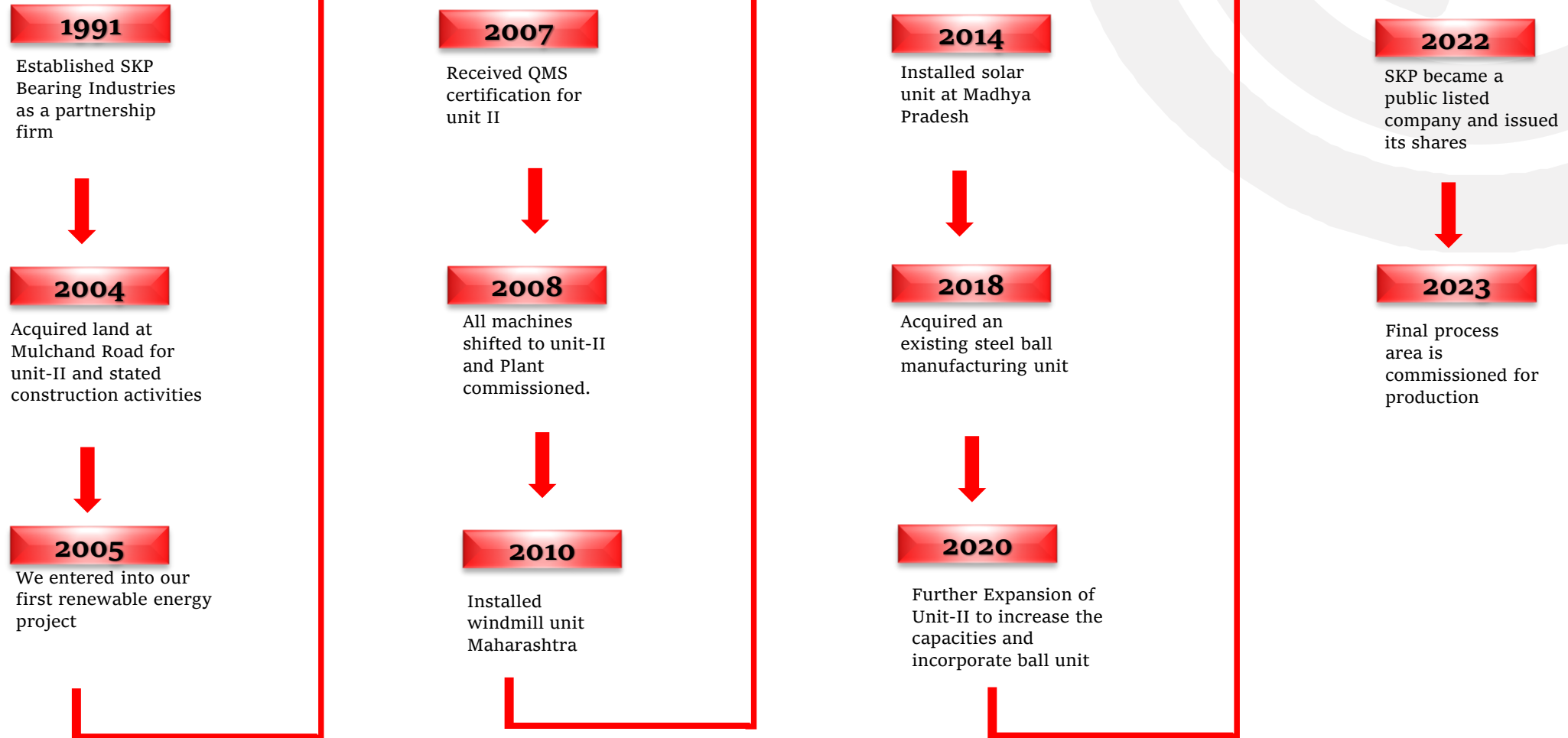

Beginning 1991, Formed as a Partnership Firm in the name and style of “S K P Bearing Industries”

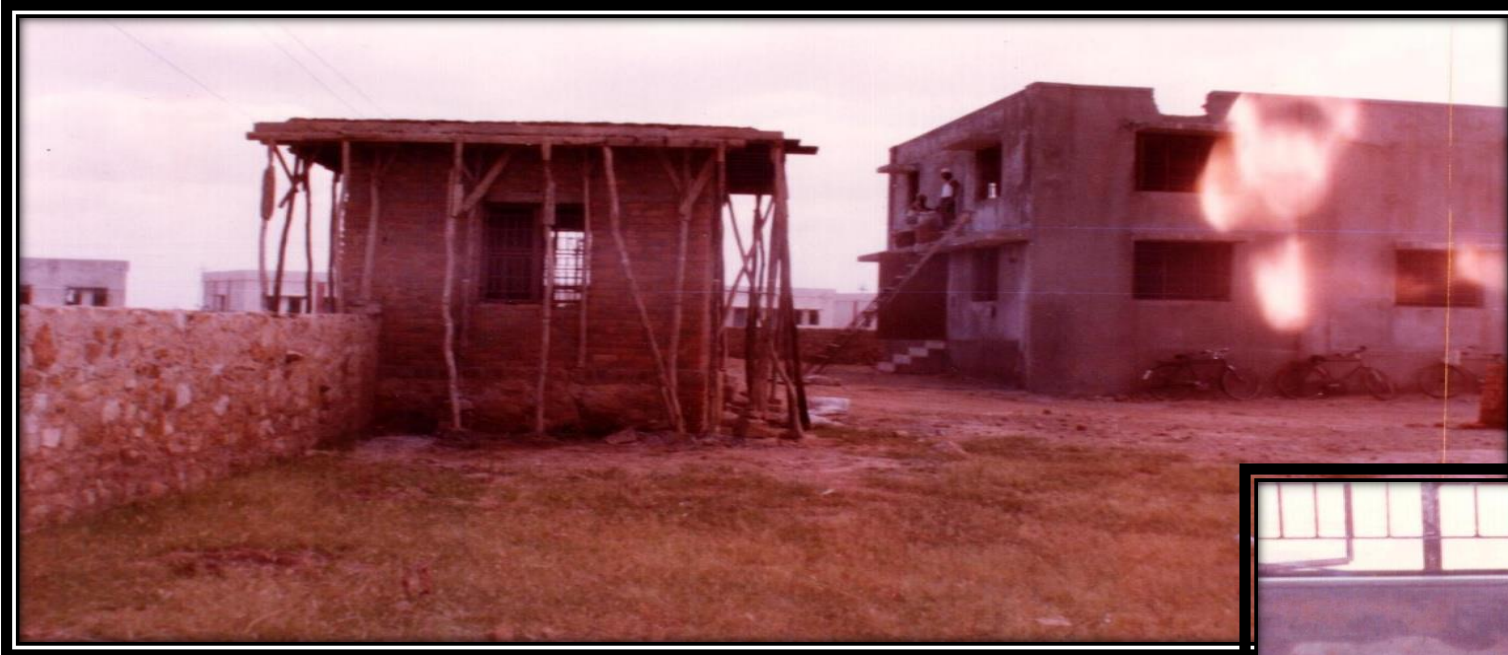



## Product Range.

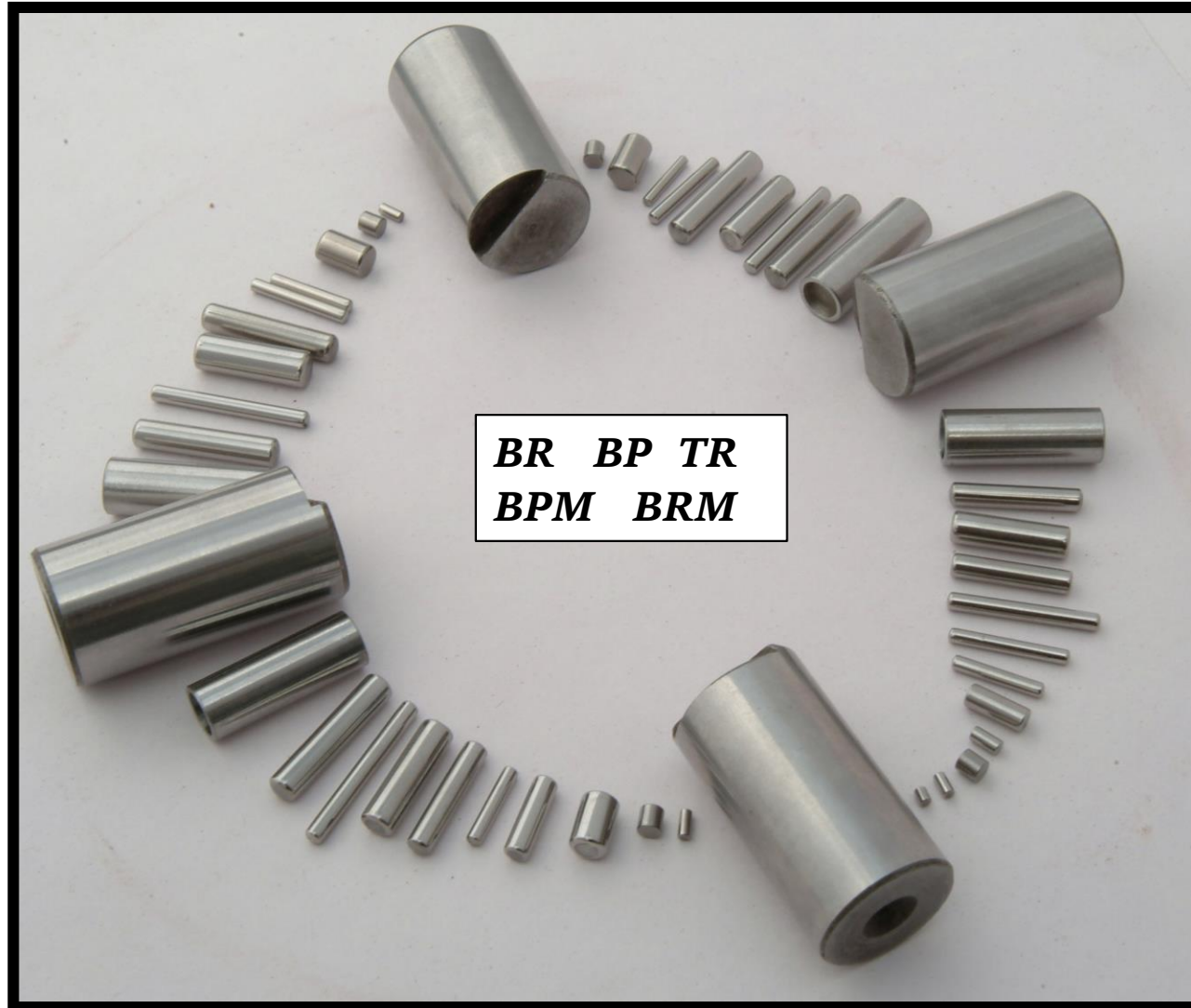

### ***Range of production :***

- ***Diameter: 1.25mm to 30.00mm***
- ***Length: 3.00mm to 100mm***

# SKP PRODUCTS APPLICATIONS



CAM FOLLOWERS



UNIVERSAL JOINTS

Transmission / Starters

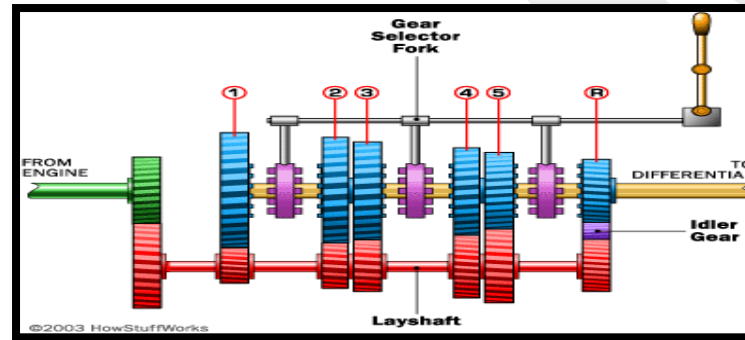

Car Gears

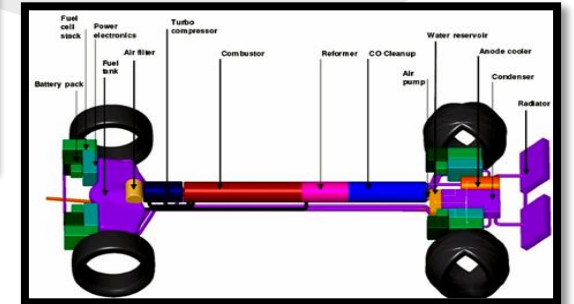

WATER PUMPS

Accelerators

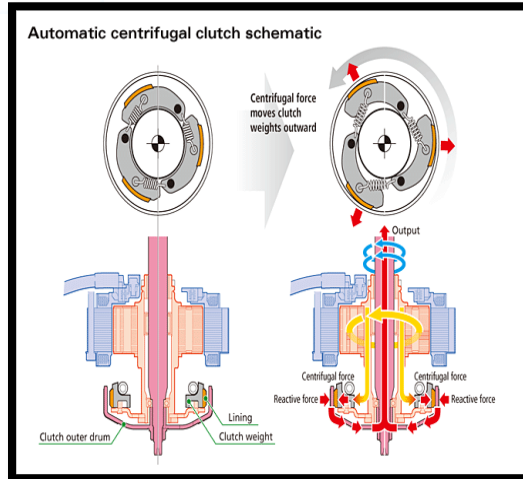

Steering

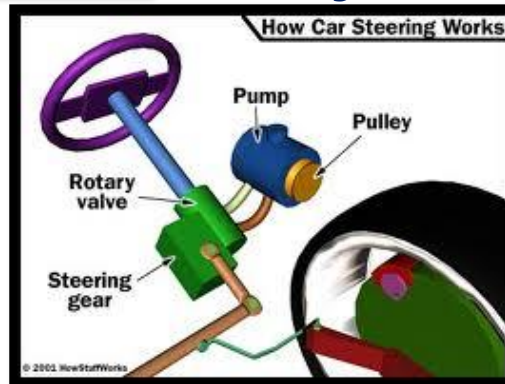

Motorcycle gears

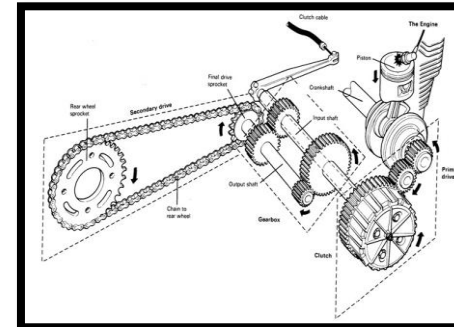

CAM LIFTERS



ROCKER ARMS

Propeller Shaft

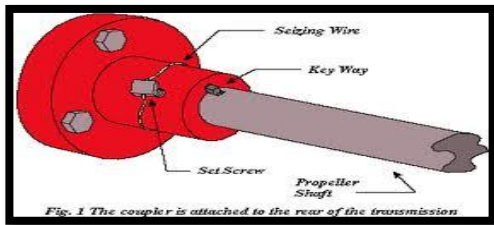

FOR VARIOUS APPLICATIONS.





# Factory Outlook -Unit I







**2004 & 2008 Third phase expansion,** setting up of Manufacturing Unit at Survey No. 2127, Mulchand Road







## 2018, Ball Plant

- In February 2018, SKP took over an already existing ball manufacturing plant in Jaipur.
- The plant was run in the same location for 2 years. Later in 2020 the plant was shifted and consolidated with the Surendranagar plant.



## Product Range.



*Balls of G10 grade from  
3.968 mm to 22.225 mm*



# SKP PRODUCTS APPLICATIONS



## Seats



## Bearings



## Steering

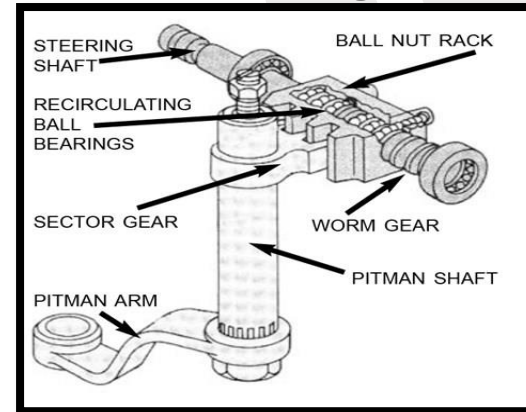

## WATER PUMPS

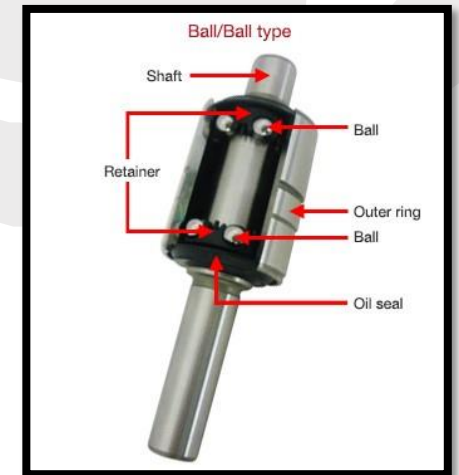

## Cycles



## Brakes

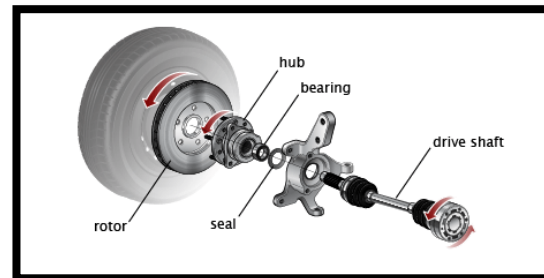

## Accelerators

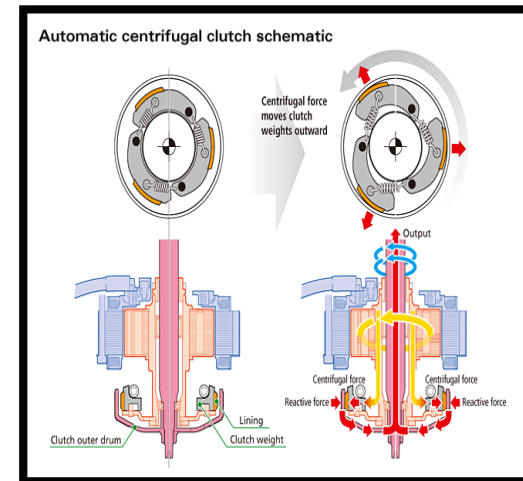

FOR VARIOUS APPLICATIONS

 **2020, Fourth Expansion**



**SKP factory is spread over an area of 54000 Sq. Ft.**



**Address:  
Survey No. 2127,  
Mulchand Road,  
Wadhwan,  
Surendranagar,  
Gujarat**



# Total Facility



## INSTALLED CAPACITY

**Rollers: 600 MILLION PCS / ANNUM**

**Balls: 360 MILLION PCS / ANNUM**

**Rollers: 1320 TONES / ANNUM**

**Balls: 960 TONES / ANNUM**

## UTILISED CAPACITY

**Rollers: 480 MILLION PCS / ANNUM**

**Balls: 54 MILLION PCS / ANNUM**

**Rollers: 1200 TONES / ANNUM**

**Balls: 540 TONES / ANNUM**

# Current Facility has strong Quality Assurance system :



IATF 16949  
Certified By TUV Seudland

Date Of Issue : 3.12.20

Valid Till : 2.12.23



ISO 45001  
Under Certification  
By TUV Seudland

ISO 14001  
Under Certification  
By TUV Seudland



 **2022, Converted to Public Limited.**



*Company had been converted into a public limited company and the name of our Company changed to*

**“SKP Bearing Industries Limited”**

*Issued our Initial public offering in July 2022.  
Now SKPBIL is listed on NSE i.e. National Stock exchange.*



# Board Of Directors



**Mr. S. K. Palshikar**

Promoter, Chairman & Managing Director

He specialized in Production Engineering with Masters from IIT Bombay. He has knowledge and experience of more than 30 years in the field.



**Mrs. S. S. Palshikar**

Non-Executive Director

She is experienced in Finance and administration. She is a Presidential award winner for “Outstanding women Entrepreneur”.





**Mr. Kishor Parikh**

Non-Executive Director

He is a Practicing Chartered Accountant under his firm name M/s K.C. Parikh & Associates. He has around 35 years of experience in the field of audit, taxation, accounts and finance.



**Mr. Rajeev Lokare**

Non-Executive Independent Director

He is Mechanical Engineer and has experience of around 40 years in operational excellence with the entire career focus on systems implementation and diversification for business development through expanding existing product, new product development and Joint Ventures. He has worked with various companies like Tata Motors Limited, TVS Motor Company Limited, Apollo Tyres Limited and many more.

 **2023, Final process area is commissioned.**



SKP Bearing Industries Limited ongoing project of expansion activity for final process area that is in the ground floor of the admin building has been done and put to use in this year.





➤ Other Plants





# Wind Gujarat Plant





# Wind Maharashtra Plant





 **Wind Madhya Pradesh Plant**





# Solar Madhya Pradesh Plant







➤ Road Map for the nearest future



# SKP Bearing Industries Limited Plant-III



**A separate vertical for Precision Steel Balls to manufacture high Grade balls (i.e G3, G5, G10) for Bearings and Aero Space Industries.**



To install continuous furnaces.

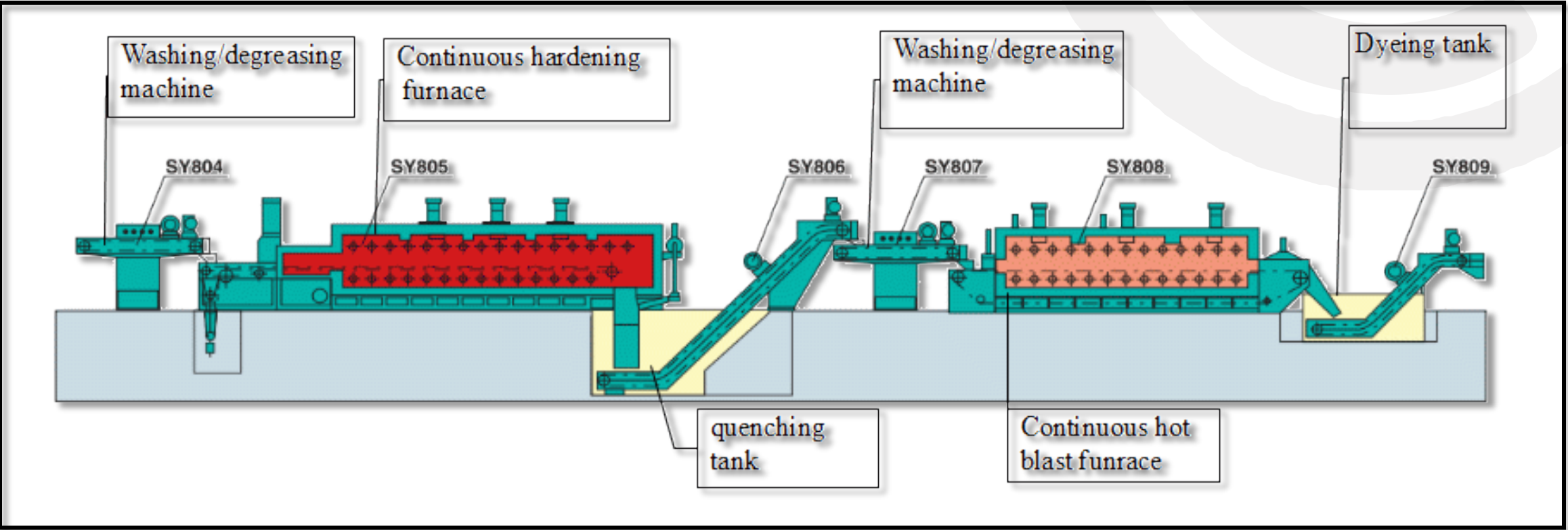



To implement Filtration plants.

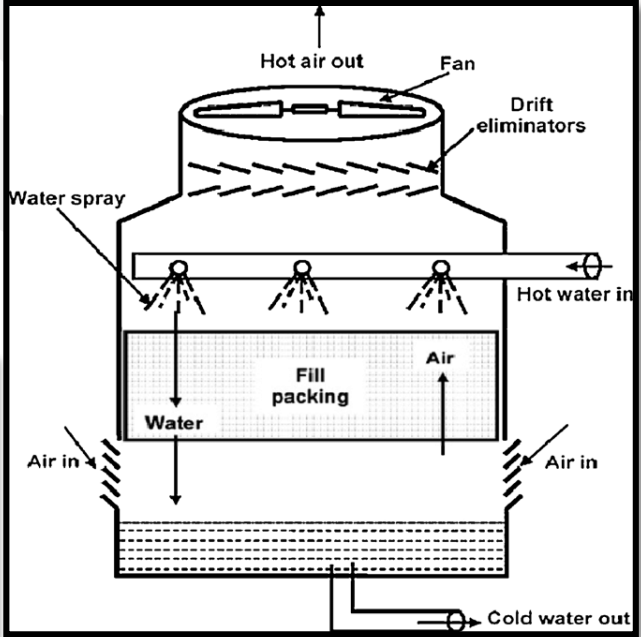
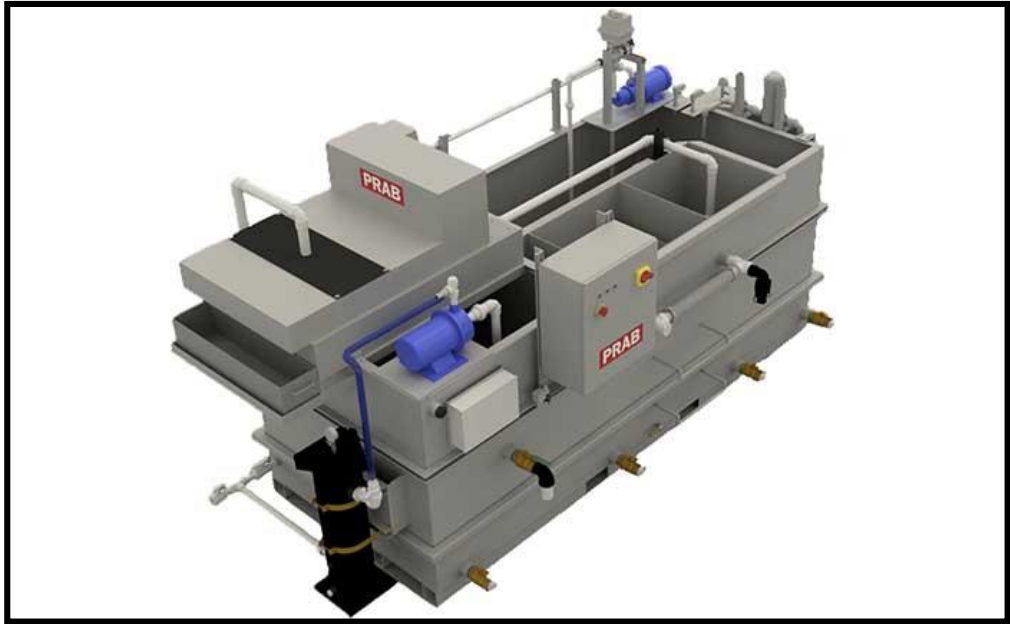



# Artificial intelligence based systems.

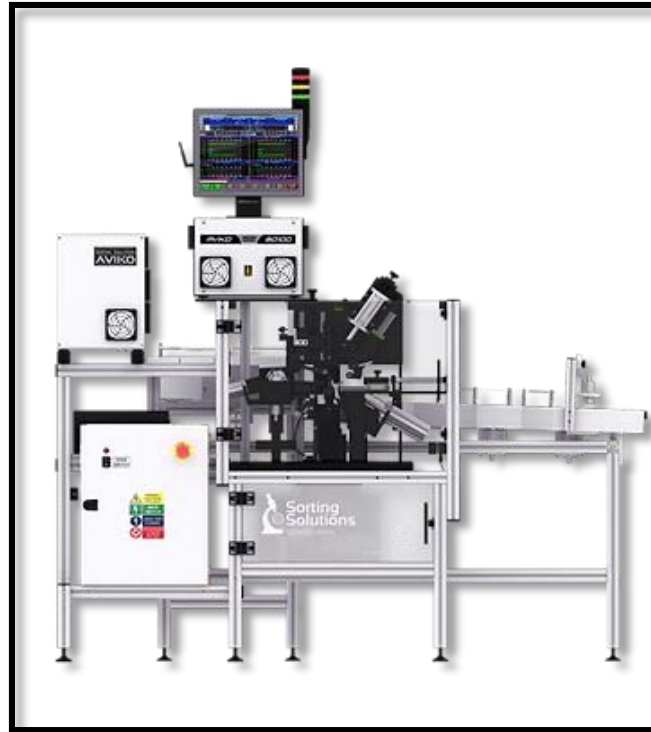



## Up gradation of ERP System



The ongoing project of ERP up gradation will enhance SKP Bearing Industries Limited operational efficiency and streamlining internal processes by up this gradation.

## Solar Energy in PM Kusum Yojna.

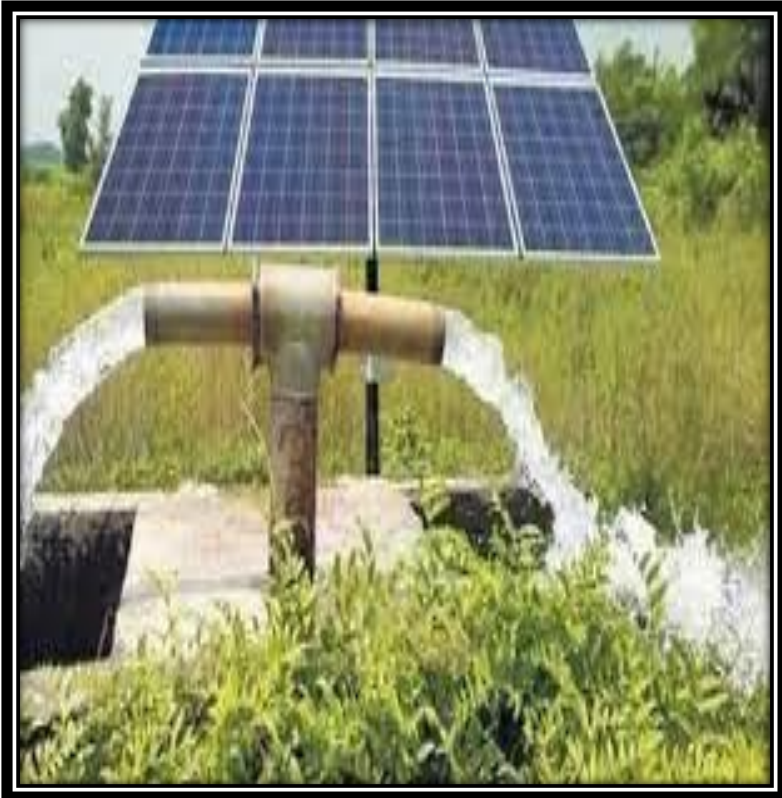

SKP Bearing Industries Limited has obtained approval for PM Kusum Yojna to generate solar energy. This gives us an opportunity to diversify revenue streams and Contribute to environmental conservation.



# Completion of Registered office building







## ➤ Welfare Activities







# Employee welfare

## Appreciation



## DOJO Trainings



## Ganesh Yag (Family Get-together)





## SKP Colony



## Canteen Facility





# Environment welfare



Rain Water Harvesting





**Awarded with Special National Award as “Outstanding Entrepreneurship” in Women General category. And subsequent special awards.**







## Sweet Distribution



# Society

## Women Empowerment training



## Tree Plantation



## Sweater Distribution



## Cultural Behavior







# Contribution in the field of education

## Uniform Distribution



## Science & Computer Lab



## Book Distribution



## SSC Board Exam Mock Test





# Restoration of Historical





An aerial photograph of an industrial facility. The main building is a large, multi-story structure with a grey facade and a curved roof section. It is surrounded by several other buildings, some with solar panels on their roofs. The facility is situated in a green, open area with trees and a paved road. A large white semi-circular graphic is overlaid on the left side of the image.

## ➤ Financial Highlights



# Financials Highlights :

## Total Revenue in (Lakhs)

■ Revenue

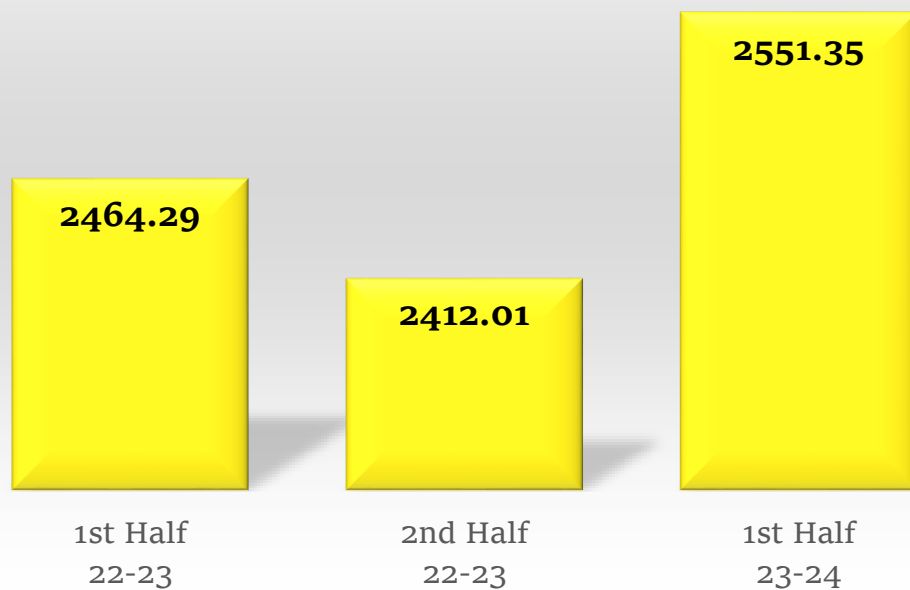

## EBITDA in (lakhs)

■ EBITDA

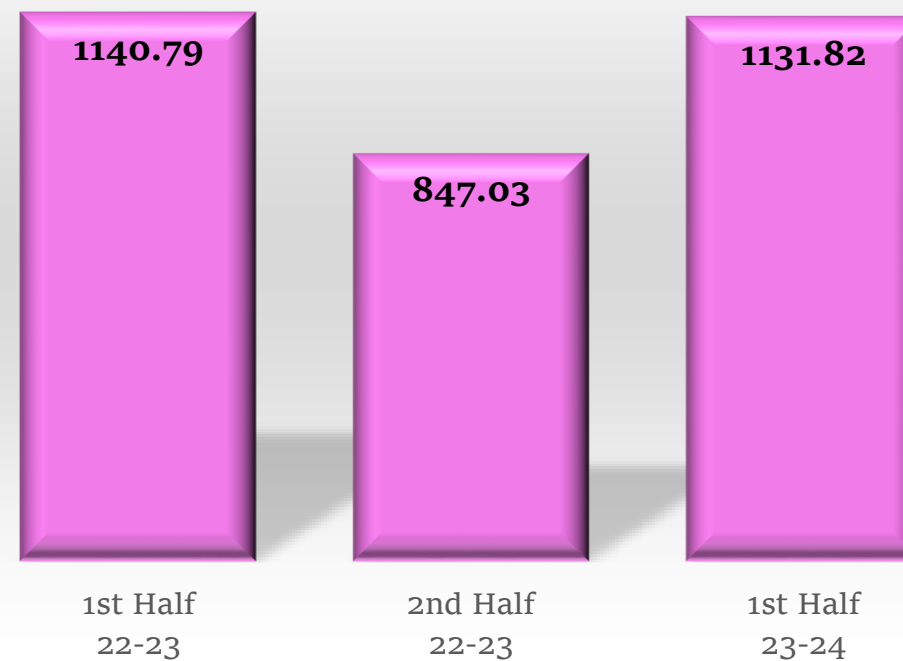

# Financials Highlights :

## Profit comparison

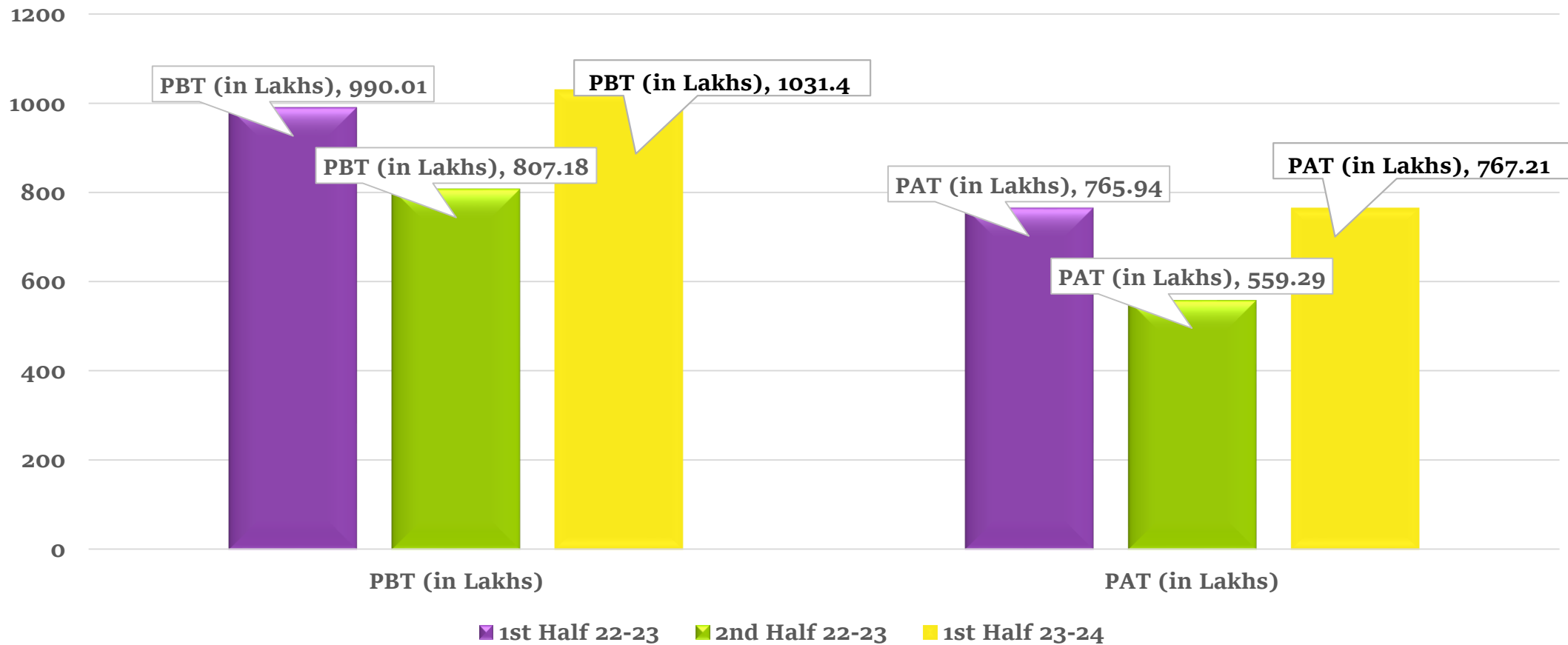



# Half yearly Highlights:

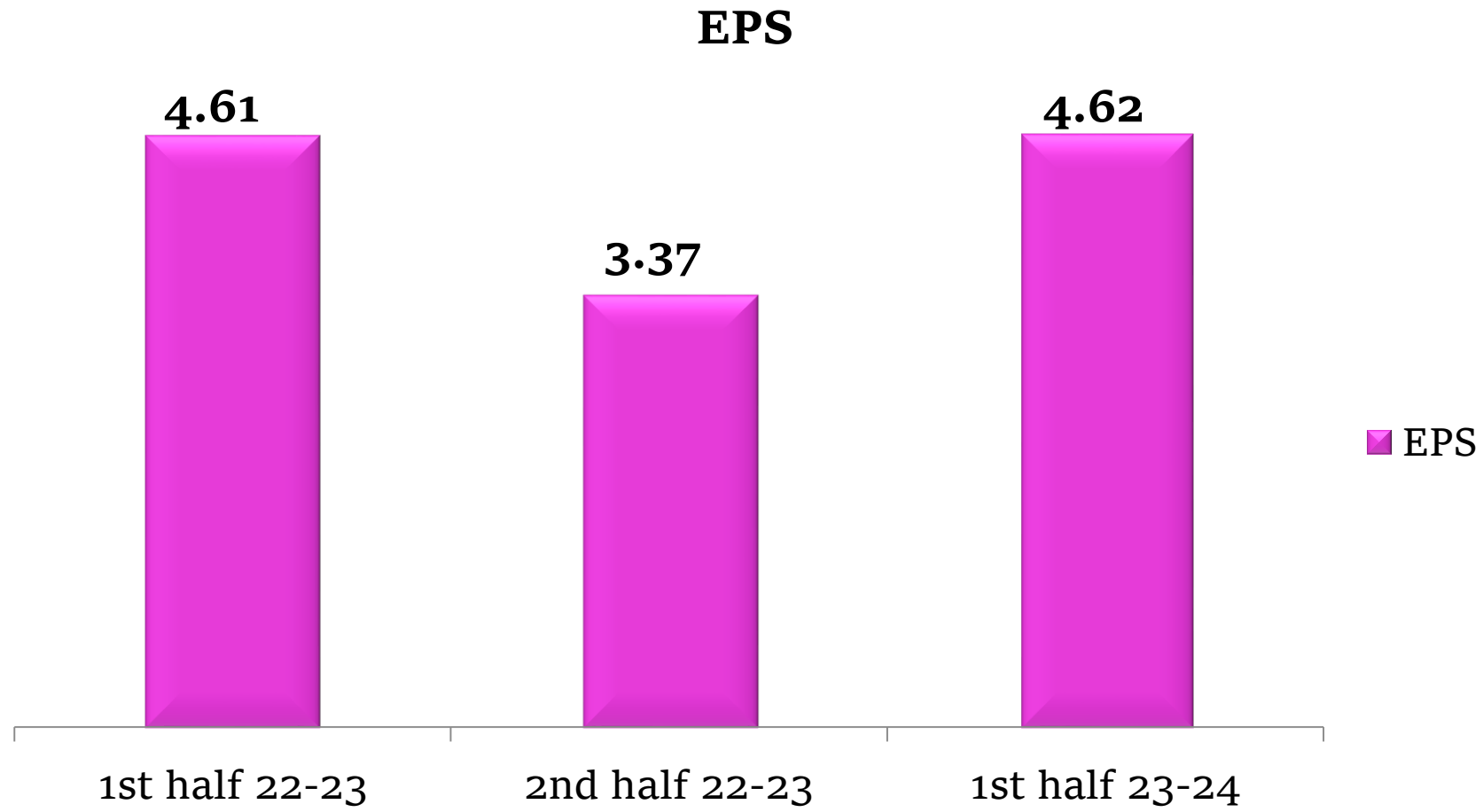

# Balance Sheet:

All figures are in ₹ lacs	1st half 22-23	Year 22-23	1st half 23-24	All figures are in ₹ lacs	1st half 22-23	Year 22-23	1st half 23-24
<b>Balance sheet</b>							
<b>EQUITY AND LIABILITIES</b>				<b>ASSETS</b>			
<b>Shareholders funds</b>				<b>Non-current assets</b>			
Share capital	1660.00	1660.00	1660.00	Property, plant& equipment	2233.96	2168.06	2935.86
Reserves & surplus	1899.59	2458.92	3060.13	Intangible assets	-	-	-
<b>Total</b>	<b>3559.59</b>	<b>4118.92</b>	<b>4720.13</b>	Capital work in progress	244.30	752.29	548.57
<b>Non-current Liabilities</b>				Intangible assets under development	-	-	-
Long term borrowing	699.13	399.13	507.02	<b>Total</b>	<b>2478.26</b>	<b>2920.34</b>	<b>3484.43</b>
Deferred tax liabilities (Net).	15.36	40.91	62.93	Non-current investments	-	35.01	-
Other long term liabilities	-	-	-	Deferred tax assets ( net)	-	-	-
Long term provisions	-	-	-	Long term loans & advances	337.13	74.41	50.05
<b>Total</b>	<b>714.49</b>	<b>440.04</b>	<b>569.95</b>	Other non-current assets	-	0.28	-
<b>Current Liabilities</b>				<b>Total</b>	<b>2815.39</b>	<b>3030.03</b>	<b>3534.47</b>
Short term borrowing	1.01	1.42	27.77	<b>Current assets</b>			
<b>Trade payables</b>				Inventories	637.00	527.29	567.16
<b>Dues of MSME</b>	12.19	13.24	7.66	Trades receivables	1120.40	1097.62	1157.78
<b>Other Dues</b>	116.96	171.78	107.7	Cash and cash equivalents	42.87	3.04	2.39
Other current liabilities	149.57	72.99	70.13	Short-term loans and advances	61.60	118.97	267.89
Short term provisions	338.45	442.31	266.78	Other current assets	215.00	483.76	240.44
<b>Total</b>	<b>618.19</b>	<b>701.75</b>	<b>480.04</b>	<b>Total</b>	<b>2076.87</b>	<b>2230.68</b>	<b>2235.66</b>
<b>Total equities &amp; liabilities</b>	<b>4892.27</b>	<b>5260.71</b>	<b>5770.13</b>	<b>Total assets</b>	<b>4892.27</b>	<b>5260.71</b>	<b>5770.13</b>



# Profit and loss:

All figures are in ₹ lacs	1 <sup>st</sup> half 2022-23	2 <sup>nd</sup> half 2022-23	1 <sup>st</sup> half 2023-24
<b>Income Statement</b>			
Revenue	2464.29	2399.25	2551.35
COGS	649.45	722.44	662.00
Gross profit	<b>1814.84</b>	<b>1676.81</b>	<b>1889.35</b>
Employee costs	158.76	207.95	186.4
Other expense	586.89	621.83	573.89
EBITDA (Inc. other income)	<b>1140.79</b>	<b>847.03</b>	<b>1131.82</b>
Depreciation	84.94	18.84	66.98
EBIT	1055.85	828.19	1064.84
Interest	65.84	21.01	33.44
Other income	71.61	-	2.76
PBT	<b>990.01</b>	<b>807.18</b>	<b>1031.40</b>
PAT	<b>765.94</b>	<b>559.29</b>	<b>767.21</b>
EPS	<b>4.61</b>	<b>3.37</b>	<b>4.62</b>

# Accounting Ratios:

Ratios	1 <sup>st</sup> half 22-23	2 <sup>nd</sup> half 22-23	1 <sup>st</sup> half 23-24
COGS %	26.00%	30.00%	26.00%
ROCE	24.79%	18.33%	20.37%
Employee Costs %	6.44%	8.67%	7.31%
Depreciation %	3.45%	0.79%	2.63%
EBITDA %	45.00%	35.30%	44.31%
EBIT %	41.65%	34.52%	41.69%
PBT %	39.05%	33.64%	40.38%
PAT %	30.21%	23.31%	30.04%
Current Ratio x	3.36	3.18	4.66
Quick Ratio x	2.33	2.43	3.48



## Sales Comparison Product wise:

<b>Sales Comparison Product wise</b>				
<b>Sales</b>		<b>HI22-23</b>	<b>HI23-24</b>	<b>Increase/Decrease Percentage</b>
<b>SR No</b>	<b>Particular</b>	<b>Value</b>	<b>Value</b>	
1	Roller	1,920.36	1,934.15	0.72%
2	Ball	150.02	274.40	82.90%
3	Export	45.14	75.14	66.45%
4	Other Sales	128.54	43.74	-65.96%
	<b>Total</b>	<b>2,244.06</b>	<b>2,327.44</b>	
1	Energy	220.22	223.91	1.67%
	<b>Total</b>	<b>2,464.29</b>	<b>2,551.35</b>	

# Key Strengths:



1.

Our products are manufactured with advanced technology. Many of these technologies are **developed in-house**.

2

Global presence with a wide customer base across various industries. **No dependency on any one cluster of industries only.**  
Presence in auto, textile, engineering, etc sectors

3.

Well oiled team with **over 30 years of experience**. Supplying custom make products as per customer requirements

4.

Impact of electricity is reduced by **self generation of electricity** by roof top solar and wind.

5.

One of the players in **manufacturing** of multiple rolling elements in India **under single roof**. With flexible chain the develop new products.

6.

Almost **Debt free** company



## DISCLAIMER



This Investor Presentation has been prepared by SKP Bearing Industries Limited (SKPBIL) and does not constitute a prospectus or placement memorandum or an offer to acquire any securities. This presentation or any other documentation or information (or any part thereof) delivered or supplied should not be deemed to constitute an offer. No representation or warranty, express or implied is made as to, and no reliance should be placed on, the fairness, accuracy, completeness or correctness of such information or opinions contained herein. The information contained in this presentation is only current as of its date. Certain statements made in this presentation may not be based on historical information or facts and may be “forward looking statements”, including those relating to the general business plans and strategy of SKPBIL its future financial condition and growth prospects, future developments in its industry and its competitive and regulatory environment, and statements which contain words or phrases such as ‘will’, ‘expected to’, ‘horizons of growth’, ‘strong growth prospects’, etc., or similar expressions or variations of such expressions. These forward-looking statements involve a number of risks, uncertainties and other factors that could cause actual results, opportunities and growth potential to differ materially from those suggested by the forward-looking statements. Further, no representation or warranty expressed or implied is made nor is any responsibility of any kind accepted with respect to the completeness or accuracy of any information. Also, no representation or warranty, express or implied, is made that such information remains unchanged in any respect as of any date or dates after those stated herein with respect to matters concerning any statement made in this Investor Presentation. SKPBIL may alter, modify or otherwise change in any manner the content of this presentation, without obligation to notify any person of such revision or changes. This presentation cannot be copied and disseminated in any manner. No person is authorized to give any information or to make any representation not contained in and not consistent with this presentation and, if given or made, such information or representation must not be relied upon as having been authorized by or on behalf of SKPBIL. This presentation is strictly confidential. The earlier versions of this presentation, were in draft form, and should not be circulated or referred to by any person.



**Thank you**



**Looking forward to your Association**